

Protek

• 506 • 505 • 504

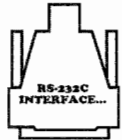

DIGITAL MULTI METER

Auto Ranging 4000 Count

WARRANTY

This multimeter is warranted against all defects of material or workmanship which may develop for any reason whatsoever, except abuse, within a period of one year from the date of purchase by the original buyer or user.

Any multimeter found defective during the warranty period and returned to the factory will be repaired, adjusted or replaced at no charge to the original purchaser. This warranty does not cover expendable items such as battery or fuse. If the defect has been caused by misuse or abnormal operating conditions, the repair will be billed to the user.

CONTENTS

INTRODUCTION

1

FEATURES

2

FUNCTIONAL DESCRIPTION

3

GENERAL SPECIFICATIONS

4

ELECTRICAL SPECIFICATIONS

5

SAFETY INFORMATION

6

MEASUREMENT PROCEDURES

7

RS232C INTERFACE

8

MAINTENANCE

9

INTRODUCTION

This meter is a super-high performance Digital Multi Meter with many useful functions and features which are indispensable for electrical and electronic measurement.

All the functions are designed to be very convenient to use. You can quickly get used to working with this meter and the great many functions integrated inside.

This meter series consists of 3 models, which are functionally classified as below.

Function	Model No.			Remark
	504	505	506	
RS232C			○	Interface with personal computer
TRUE-RMS		○	○	
BACK LIGHT		○	○	Built-in LED's illuminate display in poor lighting conditions

- * OPTION 1) Rubber Holster
 2) Temperature Probe ("K" type)
 3) Temperature Adaptor

FEATURES

3 ³/₄ digit 4,000 count auto ranging and 4 digit 10,000 count frequency counter with full annunciators and analog bargraph.

No	Features	504	505	506
1	RS232C Interface with personal computer	—	—	○
2	True RMS measurement	—	○	○
3	Back light display	—	○	○
4	Dual display, for °C/°F, Hz/ACV, etc.	○	○	○
5	10 memory locations	○	○	○
6	Timer function for alarm clock or stop watch	○	○	○
7	decibel measurement	○	○	○
8	Capacitance & Inductance measurement	○	○	○
9	Temperature (°C/°F) using "K" type thermocouple	○	○	○
10	Room Temp. (°C/°F) without any temp probe	○	○	○
11	Signal out function for logic signal injection or audio circuit checking.	○	○	○
12	Logic level check function (High, Low, ----)	○	○	○
13	Frequency measurement up to 10MHz	○	○	○
14	400 μA range measurement with 0.1 μA resolution	○	○	○
15	Warning beeper protects against wrong input to 20A fused input socket.	○	○	○
16	Overload protection for all functions	○	○	○
17	MAX/MIN/AVG mode	○	○	○
18	Relative mode	○	○	○
19	Auto power off & keep on mode	○	○	○
20	Data hold & run mode	○	○	○
21	Low battery indication	○	○	○
22	Continuity & diode test	○	○	○

FUNCTIONAL DESCRIPTION

1 PANEL CONFIGURATION

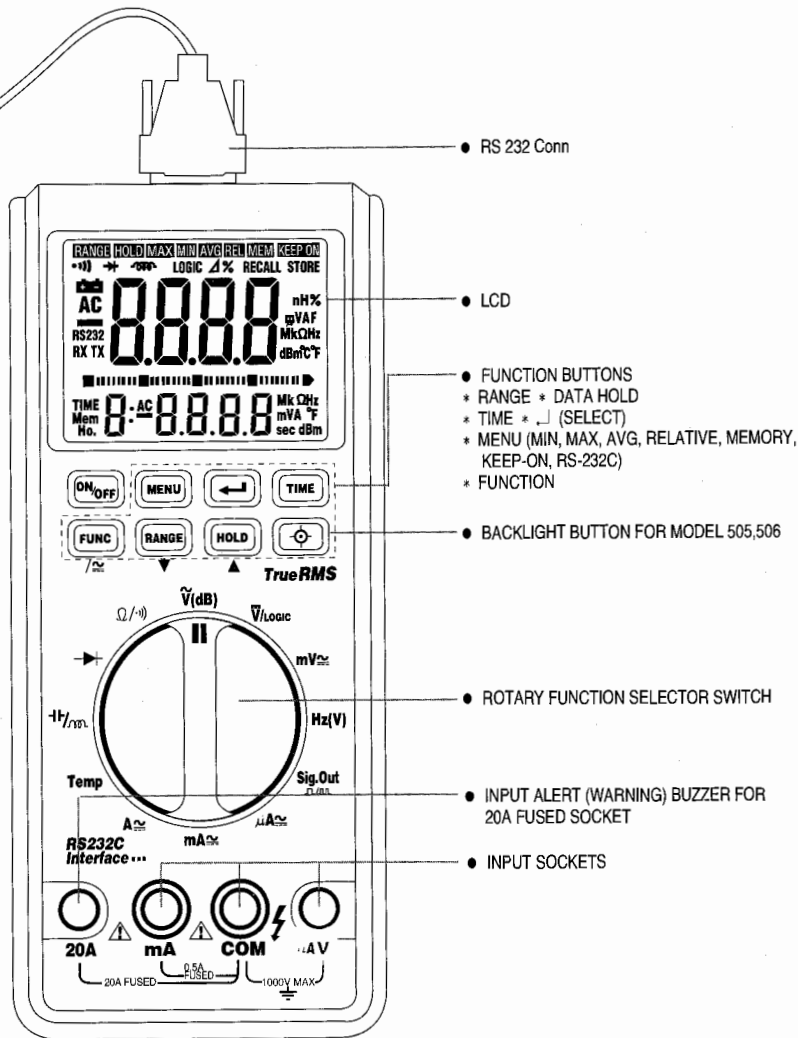

Fig. 1

2 DUAL DISPLAY

No	Function	Main	Secondary	N/A Function Mode
1	ACV(dB)	ACV	dBm	
2	Hz (ACV)	Hz	ACV	
3	Temp.	°C	°F	
4	Continuity	Open, Shrt	\varnothing	
5	Diode	Open, Shrt, Good	DCV	
6	Logic	Hi, Lo, ----	DCV	
7	Time	Measuring	Time	Hz, C, L
8	Memory	Measuring	Memory Location	Logic, Signal Out, \rightarrow , \rightarrow)
9	Hold	Hold	Current Measuring value	Signal out,
10	MAX	MAX	Measuring	Logic, Signal Out, \rightarrow , \rightarrow)
11	MIN	MIN	Measuring	Logic, Signal Out, \rightarrow , \rightarrow)
12	AVG	AVG	Measuring	Logic, Signal Out, \rightarrow , \rightarrow)
13	REL	REL	Measuring	Logic, Signal Out, \rightarrow , \rightarrow)

3 SPECIAL ANNUNCIATORS

Symbol	Description
\rightarrow)	Continuity test
\rightarrow	Diode check
\rightarrow)	Low battery indicator
REL Δ	Relative value (Measured-Reference)
REL %	Relative percent (REL Δ / Ref. \times 100)
MEM	Memory mode
RECALL	Recall the stored data from memory
STORE	Storage of the measured data into memory
Keep on	Continuous use without auto power off
RS232C	Serial data interface with computer
RX	Serial data receiving
TX	Serial data transmitting
∞	Inductance test
dBm	Decibel measurement unit (1mW, 600 Ω)

4 RANGE SELECTION

1. Selection method

No	Function	Ranges	Selection method	Press key
1	ACV(dBm)	4	Auto & manual	Range
2	DCV	4	Auto & manual	Range
3	mV(AC/DC)	1	Fixed	
4	Hz (ACV)	4	Auto	
5	Resistance	6	Auto & manual	Range
6	μA (AC/DC)	1	Fixed	
7	mA(AC/DC)	1	Fixed	
8	20A(AC/DC)	1	Fixed	
9	Continuity	1	Fixed	
10	Logic	1	Fixed	
11	Diode	1	Fixed	
12	Capacitance	1	Fixed	
13	Inductance	1	Fixed	
14	Temp	1	Fixed	
15	Signal out	3	Manual	Func

2. Over range indication

"OL" appears on the display.

Note

On some special functions such as MAX, MIN, AVG, REL etc. "3999" is displayed instead of "OL".

5 Button key operation

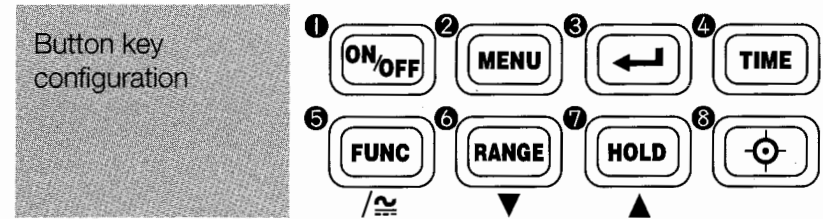

① : Power on/off switch

When not used for very long time, it would be better to turn this switch off than to depend on the auto power off function, which can make battery drained if the meter remains on for longer than about 2 months

② : Menu key

Pressing this key once to go into the menu mode. Pressing key for more than 1 sec releases meter from menu mode. Once this key is pressed, all the menu annunciators turn on, and only one annunciator at the cursor position blinks rapidly, while the previously selected menu annunciator blinks slowly.

MAX MIN AVG REL MEM KEEP ON RS232

Push menu key to move the cursor and select one of the functions shown in the above figure.

③ : Enter key

Press enter key to bring up on the screen the function selected by the menu key. The selected function will appear on the screen and all other indicators will disappear. If however, the "Keep on" or "RS232" indicator had been selected previously, they will remain on the screen.

To exit (MIN, MAX, AVG) function, press menu key once, then

the return key once.

4 Time key 

This is used for setting the time function.

When this key is pushed, 0 hours 00 minute 00 second is shown on the secondary display area on the LCD. (See Fig. Below)

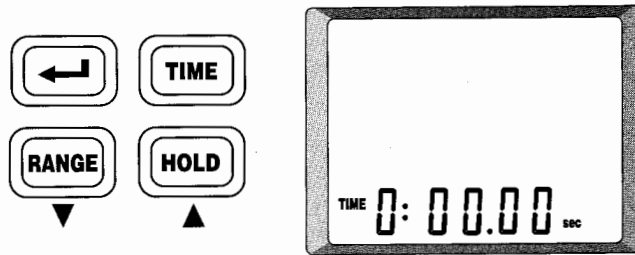

Another push of time key discards the time function and the previous normal mode is restored.

The keys for up “(▲)” or down “(▼)” are used for starting the time count up or down.

During time count up or down, if 0:00.00 or 9:59.59 is reached.

The buzzer will sound indicating the end of time count.

Pressing the time key will shut off the buzzer.

This time function also has a preset function.

After the first push of time key, if the return key is pressed, the leftmost digit will blink.

Pushing the up or down key will increase or decrease the value of the blinking digit.

After the digit you want is displayed, pushing the return key fixes the blinking digit and causes the next digit to start blinking.

In that way, time can be preset and counting up or down can be done from the preset time.

5 Function key 

This key is used for selecting the alternate function.

(When position of the rotary switch remains unchanged.)

No	Rotary switch	# 1	# 2	#3
1	V/Logic	DCV	Logic	
2	mV	DCmV	ACmv	
3	Sig. out	2048H	4096Hz	8192Hz
4	μ A	DC μ V	AC μ V	
5	mA	DCmA	ACmA	
6	20A	DC20A	AC20A	
7	Ω / \cdot)	Ω	\cdot)	
8	\pm / Ω	\pm	Ω	

Note

- 1) # 1 : No key pushed (default status)
- # 2 : The first push of the function key selects alternate measurement function.
- # 3 : The second push of the function key selects second alternate function only in case of “Sig out”.
- 2) The function key is operated toggles to another alternate function each time it is pushed.

6 Range key 

This key is used for changing from auto ranging mode to manual range mode.

When in Time mode or Memory mode, this key is used for selecting functions which are described in detail in the previous item 4 (section 3-5) time key and(3-6.)

There are two types of range operations.

One is automatic range selection (which is the default condition at power on).

The other is manual range (which is selected when the range key is pressed).

With the first push of this key, manual range mode is set up and fixed to the next range mode. Each push thereafter selects the next higher range.

Range is advanced step by step each time the key is pressed.

If the range key is pressed down for more than 1 sec, the manual range mode is released and restored to auto range mode.

3

7 Hold key 

This key has 2 functions.

One is Hold, and the other is up (\blacktriangle) function.

The up (\blacktriangle) function is used for time and memory application and is described in detail in item (section 3-5).

The Hold function is used for "freezing" the data measured at the time the key is pressed.

With the key pressed, Hold annunciator turns on and the secondary restores the current measuring data. See, Fig. Below. Another push of the hold key restores the previous testing mode.

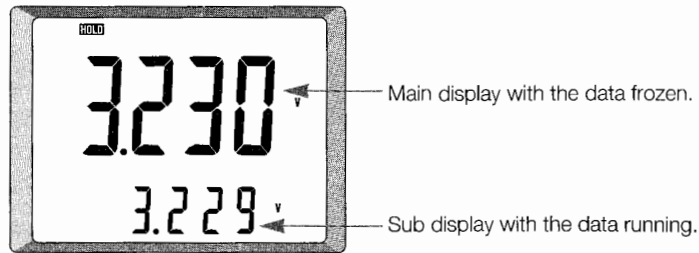

8 Back light key 

This key is used for lighting the display.

The first push turns on the back light.

The second push turns the back light off.

This back light has an auto shut off function, which will automatically extinguish the back light about 2 minutes after the light turns on.

Use of this auto-off feature saves battery life.

About 20mA current is required to operate LED Back Light. It would be better to turn the light off unless needed.

3

6 MENU FUNCTIONS

1) MAX/MIN/AVG 

These functions are used for obtaining the Maximum, Minimum or Average value of the measured data.

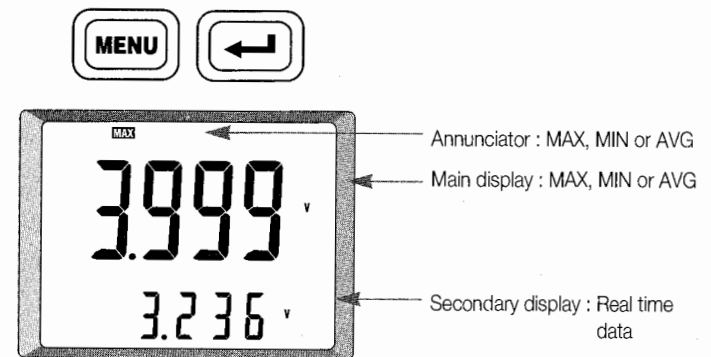

Once MAX is selected, the maximum value is shown on the main display, while the secondary display shows the present readings. Likewise for Min and AVG.

MAX, MIN and AVG functions have only the fixed range.

Before you set meter to MIN, MAX or AVG modes, Manually select the desired range. When the Maximum or Minimum value is reached on a selected range(i.e. 3.999 or -3.999), that value will be displayed instead of O.L.
The AVG mode calculates true average for all the measured data acquired during the period in AVG.

2) REL **REL**

Relative mode allows the operator to measure values with respect to a reference value other than zero.

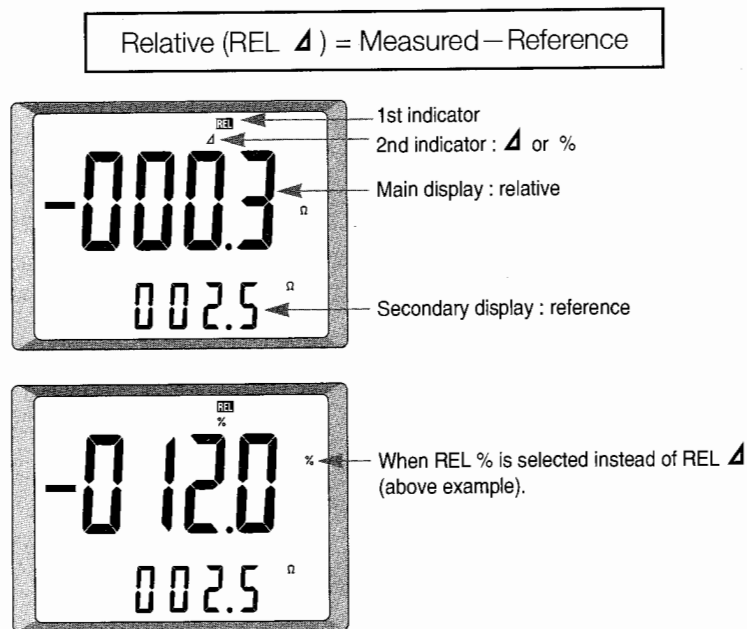

The relative value is expressed as a percent of the reference value.

$$\text{REL } \% = 100 \times \text{Relative} / \text{Reference}$$

1. Press menu key to display menu. Move the cursor to REL using menu key.
 2. Push return key, Indicators of \blacktriangle and % will appeared, \blacktriangle will blink, but % will not.
 3. Each push of menu key makes the cursor move and the related indicator blink. So \blacktriangle or % can be selected as needed.
 4. Push the return key, and the relative mode will be set up and the relative measurement will be made.
- ※ This REL mode is only available for numerical value measurement.
It is not available for logic, continuity and signal out.

3) MEM **MEM**

Up to 10 measurements can be stored in memory and recalled at anytime, by using the menu, return, up(\blacktriangle) and down (\blacktriangledown) keys.

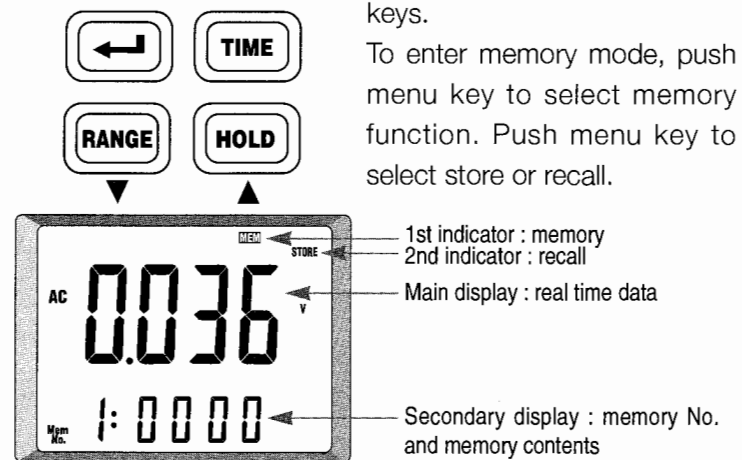

In the memory store mode.

The memory No. "0" has a special function, which can be used to input an arbitrary numerical value by manual operation of up,

down and return keys.

After entering the memory store mode, if you go to memory No.zero with the up or down key, the memory No. "0" will blink. Now push the return key and the up or down key, and "-" indicator will blink. If return key is pushed, the "-" indicator is fixed and the next digit will blink.

Any numerical value you want can be set by using up or down key.

After this, if the return key is pushed, the next right digit will blink. In that way all the rest of digits can be set. Finally the memory No. "0" will blink again. Now you can go to other memory No. using the up or down key or exit to other test mode using the menu key.

Other memories except for No. "0" memory are used for storing measurement data. Whenever the return key is pushed, the memory is updated and stored with the present measurement value.

In memory recall mode, up to 10 memory location can be recalled at anytime.

This 10 memory is not erased even with the meter in the auto power off mode.

4) Keep on **KEEP ON**

When the meter is to be used continuously for more than 30 minutes, the auto power off function should be disabled.

The "Keep on" function disables auto power off function for continuous use of the meter until the battery is drained.

1. Push menu key
2. Move the cursor to the "Keep on" position
3. Push return key

4. Then the annunciator "Keep on" will be turned on to indicate that the meter is in the "Keep on" mode.

5. To exit the "Keep on" mode, one method is to use the menu key, another method is to turn the power off.

This "Keep on" mode operates independent of other modes and functions.

Therefore this mode remains on regardless of any mode change with button key or rotary switch.

5) RS232 **RS232**

This RS232 mode is also operated independent of other modes and functions.

Refer to the chapter 8 for detailed description.

GENERAL SPECIFICATION

7 MODES APPLICATION

NO	Functions	MAX	MIN	AVG	REL	MEM	Keep-on	RS232	RNG	HOLD	TIME
1	ACV(dB)	○	○	○	○	○	○	○	○	○	○
2	DCV	○	○	○	○	○	○	○	○	○	○
3	Logic						○	○		○	○
4	DC mV	○	○	○	○	○	○	○		○	○
5	AC mV	○	○	○	○	○	○	○		○	○
6	Sig Out										○
7	Hz(ACV)	○	○	○	○	○	○	○		○	
8	DC μA	○	○	○	○	○	○	○		○	○
9	AC μA	○	○	○	○	○	○	○		○	○
10	DC mA	○	○	○	○	○	○	○		○	○
11	AC mA	○	○	○	○	○	○	○		○	○
12	DC 20A	○	○	○	○	○	○	○		○	○
13	AC 20A	○	○	○	○	○	○	○		○	○
14	RESISTANCE	○	○	○	○	○	○	○	○	○	○
15	CONTINUITY						○	○		○	○
16	DIODE						○	○		○	○
17	CAPACITANCE	○	○	○	○	○	○	○		○	
18	INDUCTANCE	○	○	○	○	○	○	○		○	
19	TEMPERATURE	○	○	○	○	○	○	○		○	○

1 MEASURING METHOD

1. A/D Conversion : 4000 Count resolution dual slope integration
2. Digital count : 10000count resolution

2 DISPLAY

1. Type : LCD
2. View area : 47 × 62 mm
3. Segments : Total 142
 - 21 for Analog Bargraph
 - 10 for Menu Indicator
 - 14 for Annunciators
 - 25 for Measurement unit
 - 31 for Main display
 - 39 for Secondary display
 - 2 for Polarity sign (Negative)
4. LED back light (except for 504)
 - ※ Auto light off : Approximately 2 min.

3 ENVIRON MENTAL

Item	Operating	Storage
Temperature	0 to 50℃ (32 to 122°F)	-40 to 70℃ (-22 to 158°F)
Humidity	80% RH max. No wetting	95% RH max. Battery removed

- ※ Temp coefficient : $0.1 \times (\text{Specified accuracy}) / \text{℃}$
 for 0 to 18℃ or 28 to 50℃
 (32 to 64°F or 82 to 122 °F)

4 MAXIMUM INPUT & PROTECTION TYPE

Rotary Switch	V-COM	mA-COM	20A-COM	Protection
ACV (dB)	1000V peak			10M Ω 1/2W
DCV / Logic				
mV AC /DC	250V rms			PTC 500 Ω
Hz (ACV)				
Sig. Out				
Ω / Continuity				
Diode				
C / L				
Temp				
μ A				
mA		0.5A 250V		Fuse
20A			20A 250V	Fuse, W/B

Note

W/B (Warning beep) : Incorrect insertion of the test lead plug into 20A input socket while in any other function than 20A will cause the warning beeper to sound.

5 POWER SUPPLY

- Type : 9V Battery, NEDA 1604 or 6F22 or 006P, carbon zinc or alkaline
- Power consumption : 30mW typ. (3.5mA typ.)
60 hrs typ. for continuous operation with carbon zinc battery.
120 hrs typ. with alkaline battery
- Auto power off : After 30 ± 1 min. of no key operation except

for Hz, C, L

After 25 to 50min. for Hz, C, L.

- Low battery indication : at below 6.9 ± 0.5 V

6 MECHANICAL

- Dimension : 88(W) \times 37(H) \times 199(L)MM
- Weight : 410g

7 SAFETY

Designed in compliance with UL1244 and IEC1010

8 ACCESSORY

- Basic : (1) Test lead (Red & Black) 1set
(2) Alligator clip (Red & Black) 1set
(3) Battery 9V 1pc
(4) Spare fuse 0.5A, 250V 1pc
(5) Instruction manual 1pc
(6) RS232 cable (for 506 only) 1pc
(7) Diskette (for 506 only) 1pc
- Option : (1) Holster
(2) "K" type thermo couple temperature probe
(3) Temperature adaptor for "K" type probe

ELECTRICAL SPECIFICATIONS

- ※ Accuracy in complete spec. is given as :
 $\pm \{ (1\% \text{ of reading}) + (\text{Number of least significant digits}) \}$
- ※ Accuracy in specified at $23^{\circ}\text{C} \pm 5^{\circ}\text{C}$ ($75^{\circ}\text{F} \pm 9^{\circ}\text{F}$) with relative humidity up to 80% for a period of one year after calibration.

1 DC VOLTAGE

Function	Range	Resolution	Accuracy	Impedance
DCmV	400mV	0.1mV	0.3% + 2d	> 1G Ω
DCV	4V	0.001V	0.5% + 2d	10M Ω
	40V	0.01V		
	400V	0.1V		
	1000V	1V		

2 AC VOLTAGE

Function	Range	Resolution	Accuracy	Frequency
ACmV	400mV	0.1mV	1% + 3d	50Hz ~ 1KHz
AC V	4V	0.001V	1.5% + 5d	50Hz ~ 100Hz
	40V	0.01V		50Hz ~ 500Hz
	400V	0.1V		
	750V	1V		

Note

- 1) ACmV INPUT IMPEDANCE : > 1G Ω SHUNTED WITH < 3nF
 AC V INPUT IMPEDANCE : 10M Ω SHUNTED WITH < 100PF
- 2) True RMS Crest Factor

Waveform	Crest Factor	Additional Error
Square	1	0.2%
Sine	1.414	0%
Triangle	1.73	0.3%
Others	2	0.5%
	3	1.7%

- 3) Model 504 does not have true RMS function, but average conversion.

3 DC CURRENT

Function	Range	Resolution	Accuracy	Burden Voltage
μA	400 μA	0.1 μA	1.0% + 2d	1mV / μA
mA	400mA	0.1mA		1mV / mA
20A	20A	0.01A		10mV / A

4 AC CURRENT

Function	Range	Resolution	Accuracy	Frequency
μA	400 μA	0.1 μA	1.5% + 3d (3.0% + 5d)	50Hz ~ 100 Hz (100Hz ~ 1KHz)
mA	400mA	0.1mA		
20A	20A	0.01A		

Note

- 1) Burden voltage : Same as that for DC current
- 2) 10A to 20A : 30 sec. MAX
- 3) μA : PTC Protected and no fuse
- 4) True RMS Crest Factor : Same as that for ACV

5 RESISTANCE

Range	Resolution	Accuracy	Open circuit
400 Ω	0.1 Ω	0.5% + 2d	2.5V
4k Ω	0.001k Ω		1.2V
40k Ω	0.01k Ω		
400k Ω	0.1k Ω		
4M Ω	0.001M Ω	1% + 2d	
40M Ω	0.01M Ω		

Note

- 1) Test leads for 4 and 40M Ω measurement should be short enough to avoid instability due to external noise.
- 2) It is recommended to use a shielded cable for long distance.

6 CONTINUITY

Range	Tested	Buzzer	Main Digit	Sub Digit
400Ω	below 100Ω ± 0.5%	Audible Tone	5hrL	Displays Resistance Value
	above 100Ω ± 0.5%	No tone	OPEN	

Note

1) Open Circuit Voltage : 2.5V typ.

7 DIODE

Range	Tested	Main Display	Secondary Display
4V	below 0.5V	5hrL	Displays Diode Voltage
	Above 1.0V	OPEN	
	0.5 to 1.0V	Good	

Note

1) Open Circuit Voltage : 3.3V MAX.
2) Test Current for Diode : 1mA typ.

8 FREQUENCY

Range	Resolution	Accuracy	Impedance	Sensitivity
10KHz	1Hz	0.01% ± 2d	10MΩ // < 1nF (≅ 100pF)	1.5Vrms Sine Wave
100KHz	10Hz			
1MHz	100Hz			
10MHz	1KHz			

Note

1) ACV shown on Secondary Display is useful for simultaneous reading of Both Hz and ACV.
The specification for this ACV is described in the previous item No.2 AC Voltage.

9 DECIBEL

Range	dBm Measurable	Frequency	Accuracy
4V	-25.74 ~ 14.25dBm(0.04 ~ 3.999V)	30~200Hz	± 0.5dB
40V	-5.74 ~ 8.24dBm(0.4 ~ 2.0V)	20~1KHz	± 0.5dB
		1K~2KHz	± 1.0dB
		2K~5KHz	± 2dB
	8.24 ~ 34.25dBm(2 ~ 39.99V)	30~5KHz	± 0.5dB
		5K~10KHz	± 1.0dB
400V	31.76 ~ 54.25dBm(30 ~ 399.9V)	30~20KHz	± 0.5dB
750V	51.76 ~ 59.71dBm(300 ~ 750V)	30~20KHz	± 0.5dB

Note

- 1) Input Impedance : 10MΩ // < 100PF
- 2) 0 dBm = 0.7746V, Based on 1mW AT 600Ω Load
[dBm] = 20 LOG(V/0.7746)
- 3) Resolution : 0.01dBm for all ranges
- 4) Audio frequency area from 20Hz up to 20KHz is covered appropriately by 40V range, and so the 40V range setting with manual range key is recommended for audio measurement.

10 TEMPERATURE

Function	Range	Resolution	Accuracy
°C	-20°C~1200°C	1°C	3%+5d from -20°C up to 10°C 3%+3D up to 350°C 5%+3D up to 1200°C
°F	°F At sub digit display on the LCD is calculated and displayed by the formular °F = 32 + (9/5 × °C)		

Note

- 1) Temp. Sensor type : "K" type thermo-Couple
- 2) Room Temp. is displayed with no sensor probe connected.

SAFETY INFORMATION

11 LOGIC

Range	Tested	Main Display	Secondary Display	Remark
40V	below 0.8V	L ₀	DCV Value	Based on TTL Logic Level
	above 2.0V	H _i		
	0.8 to 2.0V	----		

12 CAPACITANCE

Range	Resolution	Accuracy	Open Circuit
100 μ F	0.01 μ F	3% + 5d	3.2V MAX.

13 INDUCTANCE

Range	Resolution	Accuracy	Open Circuit
100H	0.01H	3% + 5d UP TO 20H 5% + 5d UP TO 50H 10% + 5d UP TO 100H	3.2V MAX.

Note

- 1) Measurement Method : Measuring the inductors time Constant.
- 2) Inductor Q of LESS than 10 and coil resistances of greater than 100 Ω will cause inaccuracy.

14 SIGNAL OUT

Function	Accuracy	Waveform	Output Level
2048Hz 4096Hz 8192Hz	$\pm 0.1\%$	Square Wave 50% duty	4.0Vp - p Min. (4.5Vp - p typ.) at No Load

Note

- 1) Source Impedance : 1.5K Ω typ.

15 TIME COUNT

Range	Resolution	Accuracy	Display	Alarm
10 hours	1 sec	0.2% + 1d	Secondary Display	Buzzer Sound

Note

- 1) Alarm will Sound : at 9 hours 59 min 59 sec. in Count up mode.
at 0 hours 0 min 0 sec. in Count Down mode.

The following should be observed for safe operation and condition.

1. Do not measure the voltage in excess of 1000V
2. Observe the maximum input limit as stated in the specification.
3. Disconnect the test lead from the test points before changing the meter function and range.
4. Be careful not to touch the terminals or probe tip when measuring above 60 VDC or 25 VAC
5. This meter is designed in compliance with UL1244 & IEC1010.

MEASUREMENT PROCEDURES

1 DCV

1. Select \bar{V} /Logic with the rotary function switch.
2. Attach the probe tips to the voltage source as shown below.
3. The LCD will display the measured value along with the Bargraph.
4. If the measured is too high, "OL" will appear.

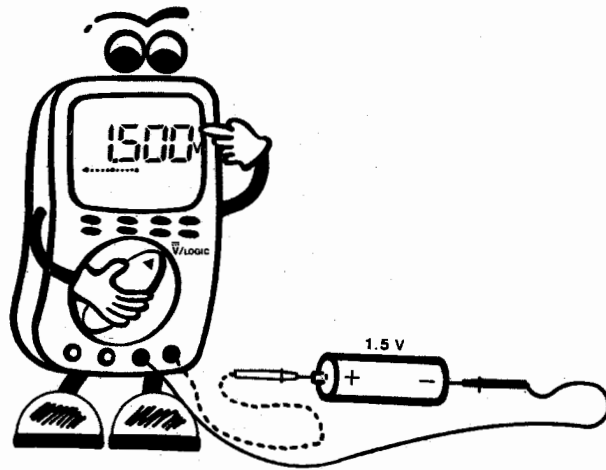

Fig. 2

DC VOLTAGE TEST

2 ACV

1. Select \tilde{V} (dB) with the rotary function switch.
2. Attach the probe tips to the voltage source.
3. The voltage will appear on the display.
4. Bargraph indicator will move to the appropriate position on the Bar-graph scale.
5. If the voltage is too high, the measurement range will be changed to the next higher range automatically. When the range is in the highest or in the manual range, too high voltage makes the display read "OL".
6. The secondary will show the decibel value calculated by the formular of $\text{dBm} = 20 \text{ Log } [V / 0.7746]$

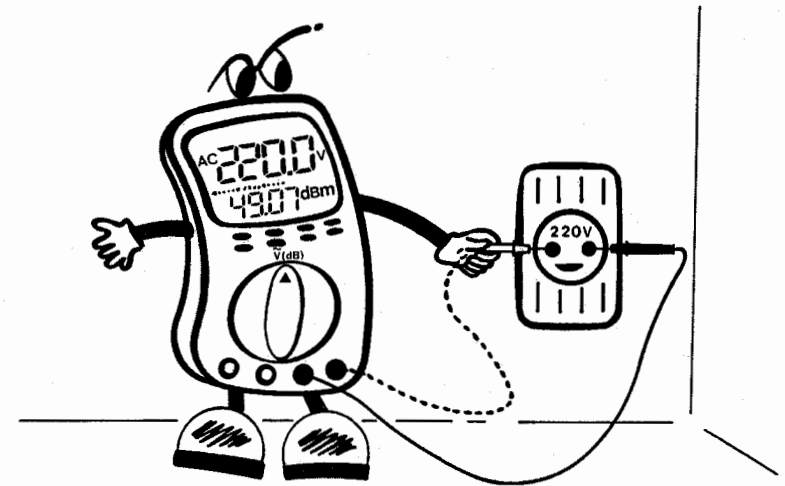
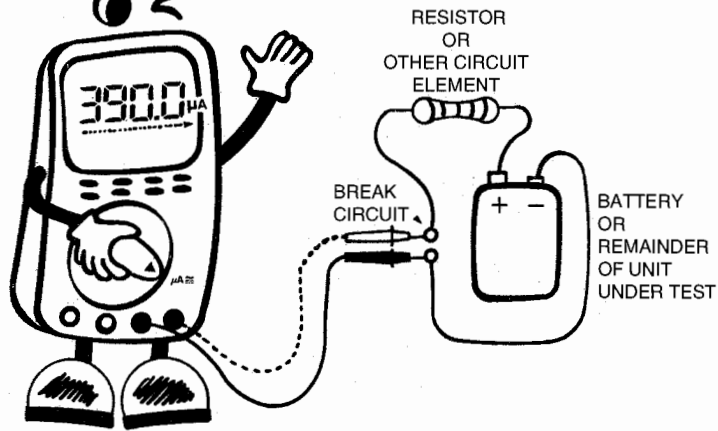

Fig. 3

AC VOLTAGE TEST

3 DC μ A

1. Select μ A \approx with the rotary function switch.
2. Break the circuit point to be measured.
3. Connect the two test leads to complete the broken circuit.
4. If the measured current is too high, the display will indicate "OL".
In this case, the higher current range (mA or 20A) should be selected.
5. The bargraph segments will indicate the measured value.



4 DC mA

1. Select mA \approx with the rotary function switch.
2. Insert the red test lead into the input socket marked as "mA".
3. The measuring procedure is the same as that of DC μ A

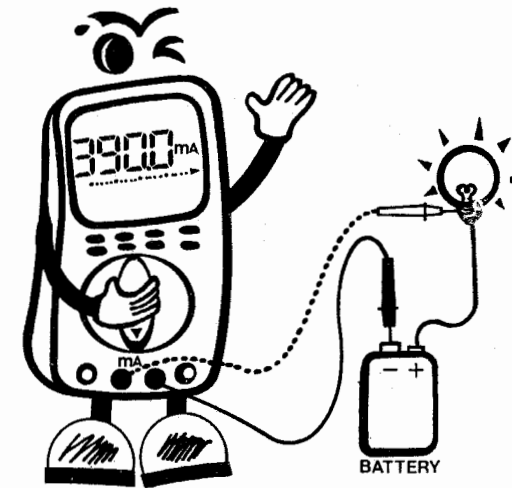

Fig. 4

LOW CURRENT (μ A) TEST

Fig. 5

CURRENT (mA) TEST

5 DC 20A

1. Select 20A \approx with the rotary function switch.
2. Insert the red test lead into the input socket marked as "20A".
3. The measuring procedure is the same as that of DC mA or μ A.
※ The 20A input socket has a special function designed for safety, which is called "Warning Beep".
When the rotary switch is set up to other than the 20A function, wrong insertion of the test lead plug into the 20A input socket will cause the warning beeper to sound.

6 AC μ A

1. Select AC μ A \approx with the rotary function switch.
Press the function key once. This will select AC μ A measuring mode.
2. The testing procedure hereafter is the same as that of DC μ A.

7 AC mA

1. Select AC mA \approx with the rotary function switch.
Press the function key once. This will select AC mA measuring mode.
2. The measuring procedure is the same as for DC mA.

8 AC 20A

1. Select 20A \approx with the rotary function switch.
Press the function key once. This will select 20A AC measuring mode.
2. The measuring procedure hereafter is the same as for 20A DC.

9 RESISTANCE

1. Select $\Omega/\text{}$ with the rotary function switch.
2. "Open" leads will display "OL" appeared on the display.
3. "Shorting" the test leads will display zero or extremely low value resistance (Test Lead Resistance).
4. Relative mode is useful to get rid of this error by subtract the test lead resistance from the measured resistance.

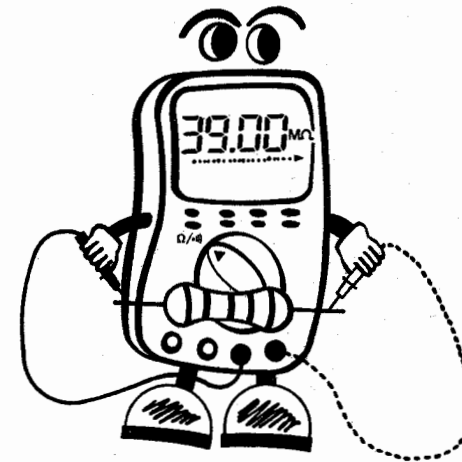

Fig. 7

RESISTANCE TEST

10 CONTINUITY

- 1) Select Ω/diode with the rotary function switch.
- 2) Press the function key one time.
- 3) The annunciator of “ diode ” appears on at the upper left of the display, the resistance value is now read in the secondary display, and the main display reads either “ OPEn ” or “ Shrt ” instead of numerical value.



Below $100\ \Omega$: Shrt together with Beep Sound
Above $100\ \Omega$: OPEn

Fig. 8

CONTINUITY TEST

11 DIODE

1. Select $\rightarrow+$ with the rotary function switch.
2. Annunciator “ $\rightarrow+$ ” will appear
3. Main display will read;
 OPEn : Open circuit or above 1.0v
 Shrt : Short circuit or below 0.5v
 Good : Good diode or 0.5 upto 1.0v
4. Secondary display will read the voltage of a measured diode.

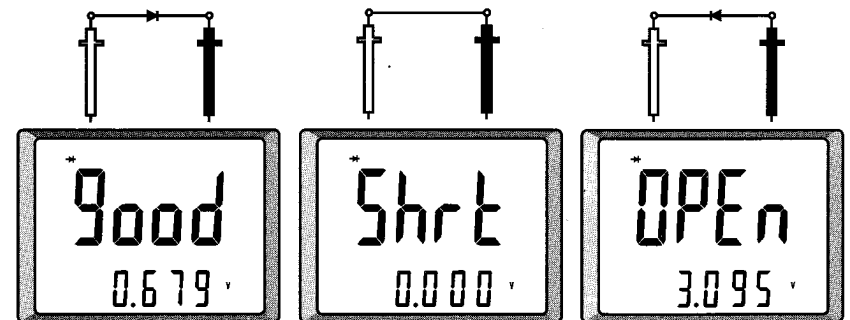
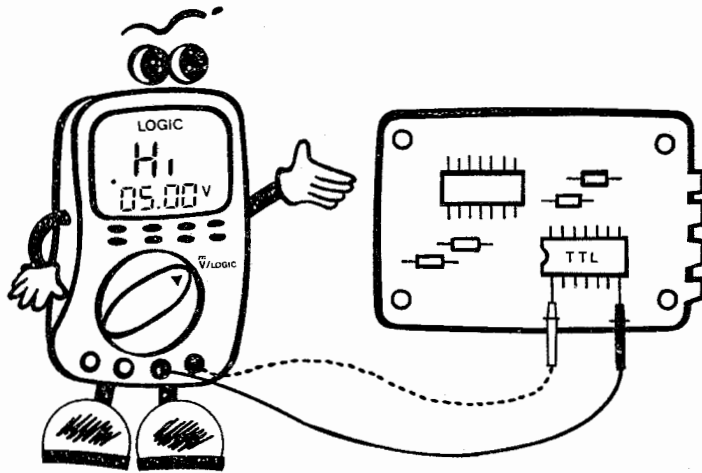

Fig. 9

DIODE TEST

12 LOGIC

1. Select \bar{V} /Logic with the rotary function switch.
Press "FUNC" key once.
2. Annunciator "Logic" will appear.
3. Main display will read
 - H_i : above 2.0V
 - L_o : below 0.8V
 - : 0.8V to 2V
4. Secondary display will read the voltage of measured Logic circuit.



13 FREQUENCY

1. Select Hz(\bar{V}) with the rotary function switch.
2. Attach the test lead tips to signal source.
3. Main display will read the measured frequency.
4. Secondary display will read measured Voltage.

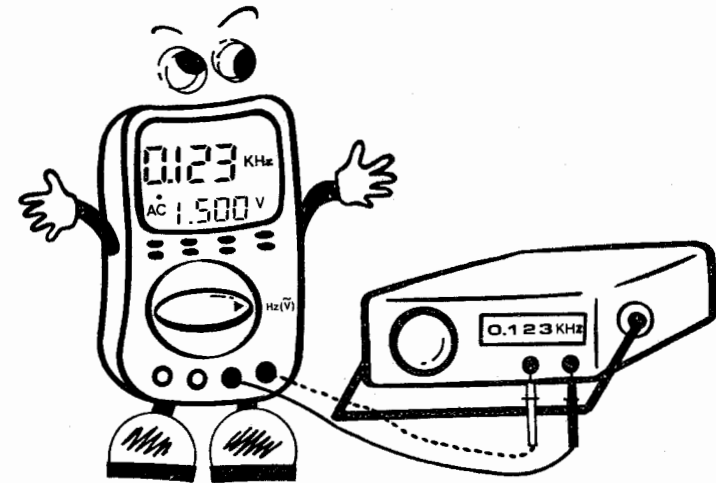



Fig. 10

LOGIC TEST

Fig. 11

FREQUENCY (Hz) TEST

14 SIGNAL OUT

1. Select sig out () with rotary function switch.
2. 2.048KHz 5Vp-p pulse signal is output to test leads.
3. If the function key is pressed one time, the frequency of output signal is changed to 4.096KHz.

Repeated pressing of the function key will cause the output frequency to sequence between 2.048KHz, 4.096KHz and 8.096KHz

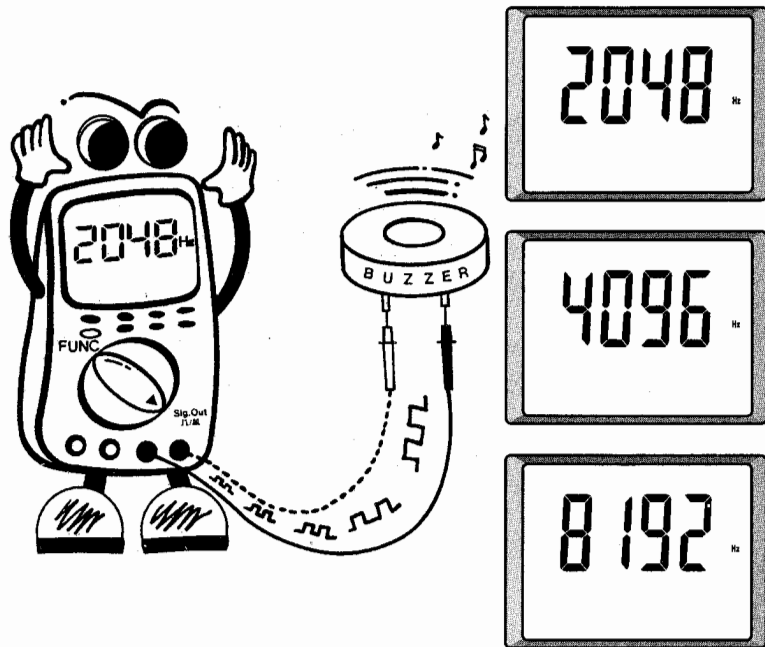

2KHz, 4KHz and 8KHz signal out

Fig. 12

SIGNAL OUT TEST

Note

In this function mode, no button key except for Time and Back Light is activated, nor does the Buzzer built in the meter make sound.

15 CAPACITANCE

1. Select μF with the rotary function switch.
2. Discharge the capacitor to be measured.
3. Attach the test lead tips to the capacitor.

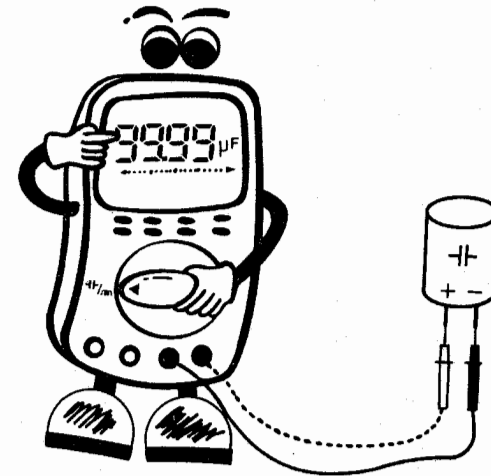

Fig. 13

CAPACITANCE (μF) TEST

16 INDUCTANCE

1. Select $\mu H/m$ with the rotary function switch.
2. Press the function key one time.
3. The Annunciator " μH " will appear.
4. Main display will show the inductance value of the measured inductor.

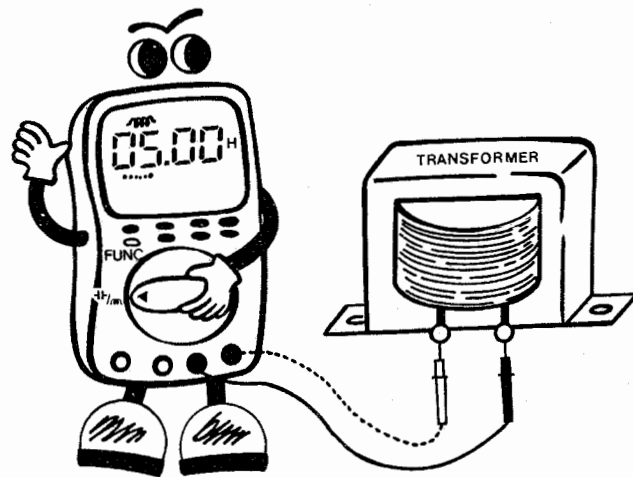

Fig. 14

INDUCTANCE (μH) TEST

17 TEMPERATURE

1. Select temp with the rotary function switch.
2. The main display will show the ambient temperature in centigrade with no test lead inserted into the input sockets. While the secondary display will read the farenhite temperature which is calculated by the formular of $^{\circ}F = (9/5 \times ^{\circ}C) + 32$.
3. The type "K" temp Probe is used for measuring temperature from $-20^{\circ}C$ up to $1200^{\circ}C$.

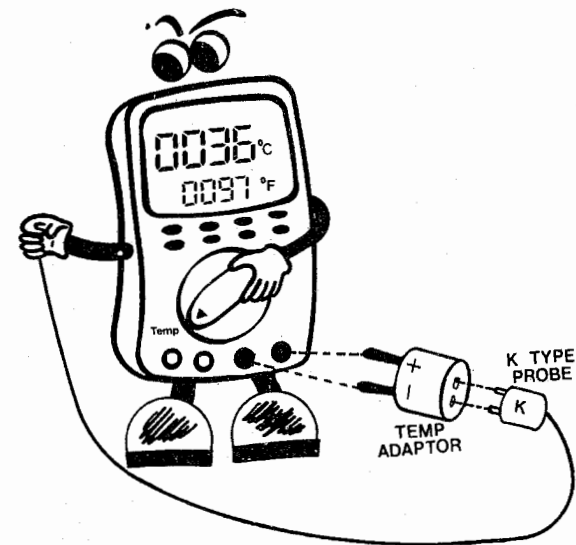

Fig. 15

TEMPERATURE ($^{\circ}C / ^{\circ}F$) TEST

RS-232C INTERFACE

1 RS-232C INTERFACE WITH A PERSONAL COMPUTER

1. Connection of PC and Meter

Connect the RS-232 cable to the built-in RS-232 connector in the Meter and to the PC serial port.

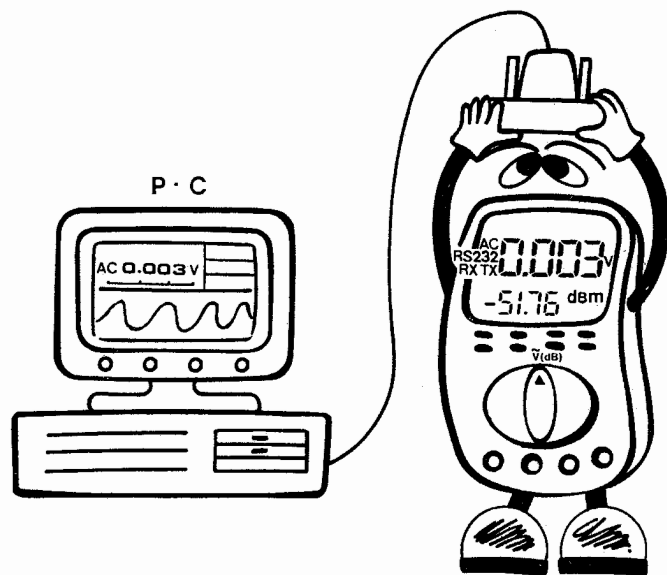

Fig. 16

2. RS232 Cable Pin Connection

<Computer>		<DMM>	
RX	3	○	2
TX	2	○	3
DTR	20	○	4
GND	7	○	5
DSR	6	○	6
RTS	4	○	7
CTS	5	○	8

(D-SUB 25Pin Female)

(D-SUB 9Pin male)

3. Communication Spec.

- Baud Rate : 1200
- Data Bit : 7
- Stop Bit : 2
- Parity : None

4. Installation of Supplied Software.

The supplied software programs run on IBM PC-Compatible computers only.

- i) Insert the supplied diskette into the drive.
- ii) Copy the files from the diskette to the computer's hard disk drive or make a back-up copy.

5. Communication with PC.

- i) Press the menu key on the meter several times until the "RS-232" annunciator blinks.
- ii) Press the return key on the meter to set the RS232 mode. Now the meter is ready to communicate with PC.
- iii) Run the execution file loaded from the supplied diskette by typing the name of the execution file at the DOS prompt.
- iv) Press the enter key and you will see the first screen showing our company's name.

Press the enter key again and you will see the 2nd screen showing some feature of the meter.

Press the enter key again and you will see the measurement screen with the menu.

- v) Now you can communicate with the meter and use the menu to access various functions.

Note

For detailed operation method, refer to the "readme" file in the supplied diskette.

6. QBASIC EXAMPLE PROGRAM (DM506.BAS)

```

10 CLS
20 PRINT "WELCOME !"
30 PRINT "<RS232 EXAMPLE PROGRAM BY BASIC>"
40 PRINT "DM506.BAS"
50 PRINT "1200 BAUD"
60 PRINT "NONE PARITY"
70 PRINT "7 DATA BIT"
80 PRINT "2 STOP BIT"
90 PRINT "COM2 PORT"
100 PRINT
110 PRINT "PLEASE"
120 PRINT "PRESS ANY KEY TO EXECUTE OR ESC TO STOP"
130 PRINT
140 RS$ = "COM2:1200,N,7,2,DS,CS,RS,CD"
150 OPEN RS$ FOR RANDOM AS #2
160 T$ = INPUT$(1)
170 IF T$ = CHR$(27) THEN 340
180 PRINT #2,T$
190 DIM R$(15)
200 I = 1
210 R$(I) = INPUT$(1,#2)
220 IF R$(I) = CHR$(13) THEN 250
230 I = I + 1
240 GOTO 210
250 FOR J = 1 TO I
260 PRINT R$(J);
270 NEXT J
280 PRINT
290 I$ = INKEY$
300 IF I$ = CHR$(27) THEN 340
310 FOR K = 1 TO 99
320 NEXT K
330 GOTO 180
340 CLOSE #2
350 END

```

Note

This is a sample program which helps users to understand the data format and the data interfacing method, and also to develop their own program.

7. DATA FORMAT

No	Function	1	2	3	4	5	6	7	8	9	10	11	12	13	14	15	Bytes
1	DC V	D	C		3	.	9	9	9		V	↓					11
2	DC V	D	C		-	3	.	9	9	9	V	↓					12
3	DC V	D	C		0	L	↓										6
4	AC V	A	C		3	.	9	9	9		V	↓					11
5	AC V	A	C		0	L	↓										6
6	DC mV	D	C		3	9	9	.	9		m	V	↓				12
7	DC mV	D	C		-	3	9	9	.	9	m	V	↓				13
8	AC mV	A	C		3	9	9	.	9		m	V	↓				12
9	DC μA	D	C		3	9	9	.	9		μ	A	↓				12
10	DC μA	D	C		-	3	9	9	.	9	μ	A	↓				13
11	DC μA	A	C		3	9	9	.	9		μ	A	↓				12
12	DCmA	D	C		3	9	9	.	9		m	A	↓				12
13	DCmA	D	C		-	3	9	9	.	9	m	A	↓				13
14	AC mA	A	C		3	9	9	.	9		m	A	↓				12
15	DC 20A	D	C		3	9	9	.	9		A	↓					11
16	DC 20A	D	C		-	3	9	9	.	9	A	↓					12
17	AC 20A	A	C		3	9	.	9	9		A	↓					11
18	RESISTANCE	R	E	S		3	.	9	9	9	M	O	H	M	↓		15
19	RESISTANCE	R	E	S		3	9	9	.	9	O	H	M	↓			14
20	RESISTANCE	R	E	S		0	L	↓									7
21	CONTINUITY	B	U	Z		S	H	O	R	T	↓						10
22	CONTINUITY	B	U	Z		0	P	E	N	↓							9
23	DIODE	D	I	O		0	P	E	N	↓							9
24	DIODE	D	I	O		S	H	O	R	T	↓						10
25	DIODE	D	I	O		G	O	D	↓								9
26	LOGIC	L	O	G		L	O	W	↓								8
27	LOGIC	L	O	G		H	I	G	H	↓							9
28	LOGIC	L	O	G		U	N	D	E	T	↓						10
29	FREQUENCY	F	R		9	.	9	9	9		M	H	z	↓			13
30	FREQUENCY	F	R		9	.	9	9	9		K	H	z	↓			13
31	CAPACITANCE	C	A	P.		9	9	.	9	9	μ	F	↓				13
32	CAPACITANCE	C	A	P		0	L	↓									7
33	INDUCTANCE	I	N	D		9	9	.	9	9	H	↓					12
34	INDUCTANCE	I	N	D		0	L	↓									7
35	TEMPERATURE	T	E	M	P		0	0	2	5	Λ	C	↓				13
36	TEMPERATURE	T	E	M	P		-	0	0	2	5	Λ	C	↓			14

Note

- 1) This is a format of the data sent out from the meter to a personal computer.
- 2) Each function data consists of 6 to 15 bytes as shown above.
- 3) Each byte has ACSII code corresponding to each character or number, and the last byte has a ASCII code (13) for carriage return(↓).

MAINTENANCE

1 GENERAL

1. Do not use abrasives or solvents and Periodically wipe the case with a damp cloth and detergent.
2. Calibrate the meter once a year to maintain its accuracy specification.

2 BATTERY REPLACEMENT

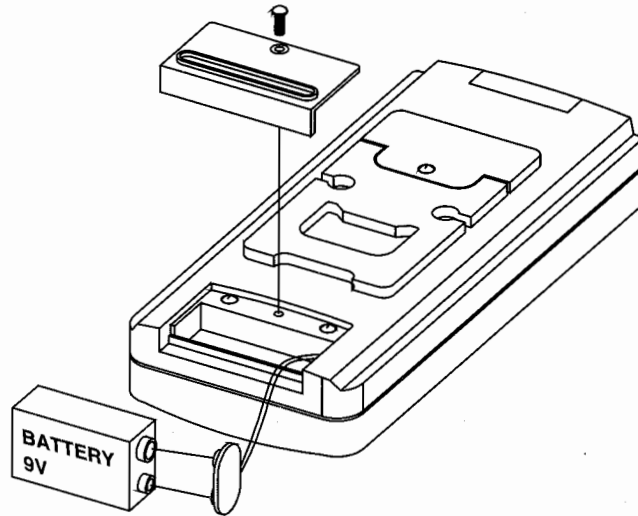

Replacing the Battery should be done according to these steps.

1. Remove the test leads from the input sockets, and turn off the power on/off switch.
2. Remove the screw from the battery cover.
3. Lift the battery cover and the discharged battery from the case.
4. Carefully disconnect the battery snap connector.
5. Snap the battery connector to the new battery terminals.
6. Reinsert the new battery into the case and be careful so that the battery leads are not pinched between the case and cover.
7. Replace the cover and reinstall the screw with a screw driver.

3 FUSE REPLACEMENT

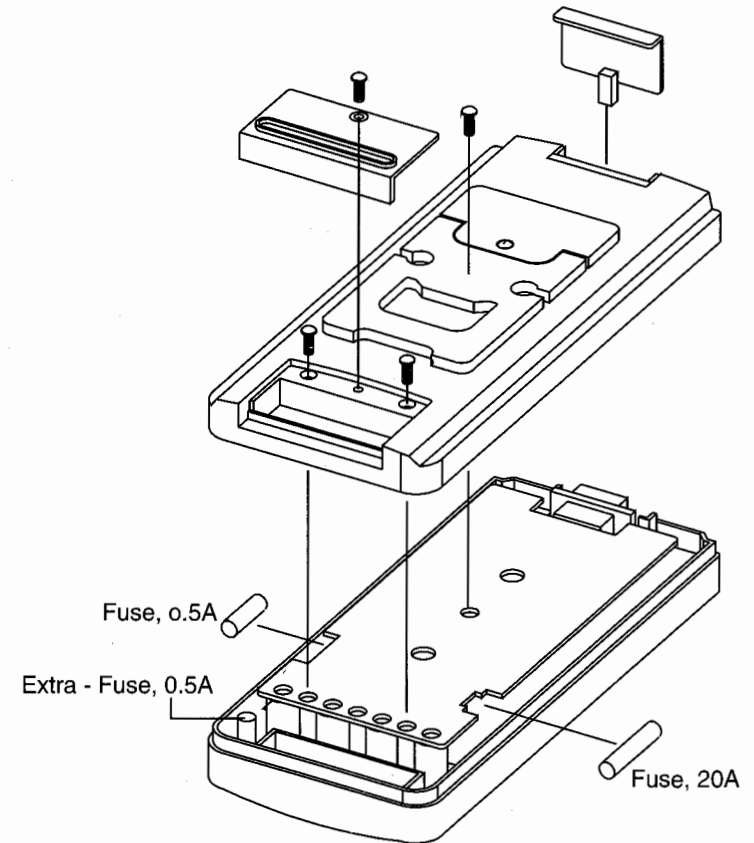

Replacing the defective fuses should be done according to the following procedure.

1. To avoid electrical shock, remove the test leads and any input signal before opening the case.
2. Remove the battery cover screw, and remove the three screw from the bottom case.
3. Lift the bottom case until it gently unsnaps from the top case.
4. Remove the defective fuse by gently prying loose one end of the

- fuse and sliding the fuse from the fuse holder.
- Install a new fuse of the same size and rating. Ensure that the new fuse is centered in the fuse holder.
 - Replace the bottom case, and reinstall all the screws.

Note

Testing the internal fuse

- Plug a test lead into the V input socket and touch the test lead tip to the mA input socket.
- Set the rotary switch to Ω . The display should read between 0 and 1 Ω .
A defective fuse will display reading more than 1 Ω .
- 20A input socket contain split contacts, ensure that the test lead tips is touched to the left half of the input socket.

4 CALIBRATION

- Remove the bottom case by performing the steps from 1 through 3 in the fuse replacement procedure.
- Proceed in the order listed below.
These adjustments should be done only by a qualified service personnel and only with appropriate equipment (Calibrator, decade box etc.)

No	Adjust	Symbol	Rotary SW	Source
1	VR2	VreF	DCmV	300mVDC
2	VR5	DCV	DCV	300VDC
3	VR3	T-RMS	ACV	300VAC 60Hz
4	VR1	20A	DC20A	10ADC
5	VR4	Temp	Temp	Thermometer
6	VR7	C	$\frac{H}{m}$	Decade Capacitance
7	VR6	L	$\frac{H}{m}$	Decade Inductance

5 REPLACEMENT PARTS & ACCESSORIES

1. Replacement parts

No	P/Cord	Name	Description	Unit	Q'ty	Remark
1	D21066	Fuse	0.5A/250V P15.0×20mm	EA	2	
2	D21088	Ceramic Fuse	20A/250V pi6.5×31.8mm	EA	1	
3	D10204	B/L PCB	50X66X0.8T XPC	EA	1	Back Light
4	D10212	B/L PCB(A)	PCB T1.0 3LED	EA	2	LED Chip
5	D13094	LCD	LS-0919A	EA	1	
6	Y08079	Top Case	ABS	EA	1	
7	Y08080	Bottom Case	ABS	EA	1	
8	T44193	Battery Cover	ABS	EA	1	
9	Y05325	Knob	ABS	EA	1	
10	T44191	Tilt Stand	ABS	EA	1	
11	T44190	Stand Holder	ABS	EA	1	
12	T44192	Connector Cover	ABS	EA	1	
13	D21092	M/Screw	FH(+) M2.6 Black	EA	1	
14	D21091	M/Screw	PH(+) M3 Black	EA	1	
15	D21093	M/Screw	PH(+) M3 Black	EA	3	
16	T44194	Key Pad	Rubber	EA	1	
17	T44195	LCD Cover	Acryl	EA	1	
18	T42106	Connector	RS232 Connector	EA	1	D-Sub, 9P

2. Accessories

No	P/Cord	Name	Description	Unit	Q'ty	Remark
1	D19036	Test Lead		EA	1	
2	D19061	RS232 Cable	6ft, D-Sub 9/25	EA	1	
3	D30035	Diskette	5.25"	EA	1	
4	A03640	Carrying Case		EA	1	
5	D29074	Manual	Instruction Manual	EA	1	
6	D18155	Holster	PVC	EA	1	Option
7	Y03063	Temp. Probe	"K" type	EA	1	Option
8	Y08070	Temp. Adaptor		EA	1	Option